

Main applications

- Plastic extruders
- Plastic injection presses
- Blowers
- Plastic and rubber processing machines
- Wrapping machines
- Packaging machines
- Thermal processes with electric heating

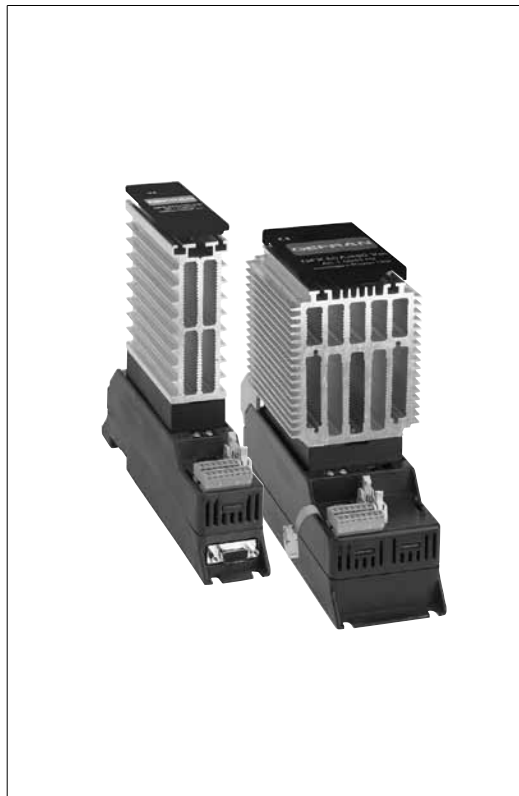

Main features

- Three versions:
 - MASTER - independent temperature control and communication unit
 - SLAVE - independent temperature control unit
 - EXPANSION - for three-phase loads
- SSR (Solid State Relay) zero crossing
- Rated voltage: 480Vac rms, 50-50Hz
- Rated current (AC1): 25A, 40A, 60A, 75A, 90A, 120A
- Protection: IP20
- Installation: DIN bar and panel
- Universal temperature input, accuracy 0.2%
- Configurable digital input
- Logic output or "cooling" relay
- Load current detection with integrated CT
- Heat/cool PID, selection of cooling fluid, self-tuning, auto-tuning, soft-start
- 4 generic alarms, LBA and HB alarms
- 2 configurable relay outputs
- Field bus for Master:
 - std: "Modbus RTU" with Serial RS485 optically
 - opt: "PROFIBUS DP", "CANopen", "DeviceNet"

PROFILE

An innovative, integrated system to control power and temperature, designed for industrial electric heating processes. The system architecture is optimized for temperature control of multizone plants. It consists of a control unit, i.e., the PID microprocessor controller plus load control device (AT and VT), and a power module (SSR) with aluminum heat sink. The system is compact and easy to install and use.

Models and communication

The system has high communication capacity and interfaces without limitation with the automation environment. Three standard protocols are available: Modbus RTU, Profibus DP and CANopen implemented in the Geflex "master," which in turn communicates with up to nine Geflex "slaves" by means of an internal bus. Every Geflex can tune to the network communication speed (baud) with a self-learning sequence. In addition to connecting to PLCs, terminals, and PCs, the "master" is able to control a control loop.

Power

Five current levels are offered: 25, 40, 60, 75, 90 and 120A, all with rated voltage of 480V, single phase.

To control three-phase loads, the system uses a connection with 3 Geflex units: a "master" unit that performs the PID control and transmits (via internal bus) the power

command to two other "expansion" units equipped with SSR module only. The power control has double SCR in antiparallel, zero crossing switching principle, with configurable proportional cycle time. The electrical connections for power and control are completely separate to increase electrical safety and reduce electromagnetic interference.

Mechanics

The mechanical elements have been carefully designed and tested for maximum ease of installation and to guarantee high resistance to vibration and thermal stress.

Diagnostic LEDs

The lower section has 3 LEDs that indicate the operating state of the field bus, temperature sensor errors, and the conducting state of the power unit.

Temperature input

The temperature input is universal and can be connected to a wide variety of signal types: thermocouples, resistance thermometers, input from 4...20mA transmitters, definable only by software, without the need for external adapter shunts. Accuracy of 0.2% guarantees excellent control of the heat process.

PID

The control algorithm adapts to every type of heat process.

Up to 14 different control modes are available: from simple ON/OFF control to single or double action heat/cool PID; for cooling, simply indicate the fluid being used.

Sophisticated and efficient algorithms for automatic tuning of control parameters provide precise process control without user intervention.

Outputs and digital input

The instrument can have up to 3 outputs: a cooling (3A, 250V) or logic (24Vdc, 35mA) relay and two optional alarm relay outputs (3A, 250V).

The outputs are freely configurable via software.

By means of internal bus, each "slave" can activate the two relay outputs on the "master" following alarm conditions to create electrical clearance or block signals set to assure safe operation of technological systems.

This further reduces electromechanical wiring.

At the logic level, there are 4 generic alarms configurable as: absolute, deviation, direct, reverse, window, in latching or non-latching mode, disabled at power-up. With the isolated digital input always available, you can select one of the two pre-settable set points select Manual-Automatic mode, reset the alarms memory, or enable the hold function.

Safety, diagnostics

At the logic level, there are 4 completely configurable generic alarms.

Efficient diagnosis of the control loop prevents breakdowns and lets the user take timely action (for example, in case of broken probe or load failure).

The LBA alarm carefully controls the control loop, while the on-board current transformer lets you directly monitor the load and activate the HB alarm in case of current failure or SSR in short.

In addition, the on-board voltage transformer lets the user monitor line voltage, power, and energy, with important benefits for safety and plant efficiency.

Software can be used to define the state of the alarm outputs or a preset power level to be supplied in case of a broken probe, thereby assuring continuous service of the individual module.

LEDs signal any fault in real time, and powerful diagnostics is available via serial. A simple command from the digital input deactivates the control zone by "software shutdown" of the instrument.

Programming

The supervision system can interrogate each individual "slave" to obtain information, to program, or configure the instrument.

For even simpler configuration, a programming kit (from notebook PC or palm PC) is available, composed of an IRDA interface unit and WINSTRUM (a guided program for Windows environment - see technical sheet).

TECHNICAL DATA

INPUTS

Input range: 0...60mV.

Sampling time: 120msec.

Accuracy: 0.2%fs ±1 scale points at 25°C.

Resolution: < 2μV for range 60mV.

Input filter: 0...20.0sec.

Zero offset adjustable in range: -999...+999 scale points.

Main input

Thermocouple, resistance thermometer, Linear.

Application: process variable.

Thermocouples:

ITS90: J, K, R, S, T, B, E, N, U, G, D, C, custom.

Cold junction compensation: internal, with automatic compensation.

Resistance thermometer:

Pt100 DIN 43710, J Pt100, custom.

Linears/Transmitters:

range 0...60mV, 0...20mA, 0...1Vdc (configurable within limits).

Possible 32 segment custom linearization.

Load control

TA, TV internal:

Ammeter:

range 0...25, 40, 60, 75, 90, 120Aac

Applicazioni: controllo corrente assorbita dal carico.

Tensione di linea:

campo 0...480Vac.

Applications: control of current absorbed by load.

Digital input

PNP 24V, 8mA (isol. 3500V)

Applications: Man/Auto, Loc/Rem, Hold, Reset alarms, select setpoint, shut down software.

OUTPUTS

Max 3 Relays / 1 Logic + 2 Relays.

- Relays

(Up to 3), NO, max 3A, 250V resistive load.

Application: cooling, alarms.

- Logic

24Vdc, 35mA.

Application: cooling, alarm.

- Continuous

0...10V; 0/4...20mA

Application: cooling, alarms.

DIGITAL COMMUNICATION, FIELD BUS

Asynchronous serial transmission.

Std. protocol: MODBUS RTU RS485 2

wires, 1200...19200 baud.

Optional protocols: CAN OPEN 10K...1M bit/sec, PROFIBUS DP 9,6...12Mbit/sec.

Safety

Detection of short circuit or opening of input probe, open loop alarm (LBA), load fault alarm (HB), overheat SCR.

PROCESS CONTROL FUNCTIONS

Control

PID, PI, PD, P, On/Off, heat, cool, heat + cool with fluid selection.

Manual/Automatic: Bumpless or with manual forcing of output.

Tuning

- Self-tuning: calculation of PID parameters at system start.

- Auto-tuning: continuous adjustment of PID values.

Special functions

Soft-start, power limitation, software shutdown.

Alarms

Up to 4:

absolute, deviation, symmetric, direct, reverse, Latching and non, LBA, HB.

Reference: PV, SP, aux input (for HB).

Multiset

Double setpoint with gradient selectable from digital input

POWER SUPPLY

24Vdc ±25%, max 5VA

POWER MODULE

	25A	40A	60A	75A	90A	120A
RATED VOLTAGE			480Vac			
WORK VOLTAGE RANGE			24...530Vac			
NON-REPETITIVE VOLTAGE			1200Vp			
SWITCHING VOLTAGE FOR ZERO			≤ 20V			
RATED FREQUENCY			50...60Hz			
POWER FACTOR			≥ 0,5			
RATED CURRENT AC1	25A	40A	60A	75A	90A	120A
REPETITIVE OVERCURRENT (t=1s)	≤ 40A	≤ 50A	≤ 100A	≤ 100A	≤ 150A	≤ 150A
NON-REPETITIVE OVERCURRENT (t=20ms)	≤ 400A	≤ 600A	≤ 1150A	≤ 1500A	≤ 1500A	≤ 1500A
I _t FOR BLOWOUT (t=1...10ms)	≤ 645A ² s	≤ 1010A ² s	≤ 6600A ² s	≤ 8000A ² s	≤ 11200A ² s	≤ 11200A ² s
CRITICAL dv/dt WITH OUTPUT DEACTIVATED			1000V/μs			
RATED ISOLATION VOLTAGE IN/OUT			4000V			
WORK TEMPERATURE			0...80°C according to dissipation curves			
Height			225mm			
Width	42mm	42mm	82mm	127mm	127mm	127mm
Depth	160mm	195mm	195mm	195mm	195mm	195mm
Weight	650gr	850gr	1300gr	1500gr	1500gr	1600gr
Protection class			IP20			
Installation			DIN guide or panel			
Notes			MOV protection			
High-speed fuses	FUS-025	FUS-040	FUS-080	FUS-080	FUS-100	FUS-125N

DESCRIPTION OF FACEPLATE

GEFLEX 25A - 40A



GEFLEX 60A - 75A - 90A - 120A



POWER

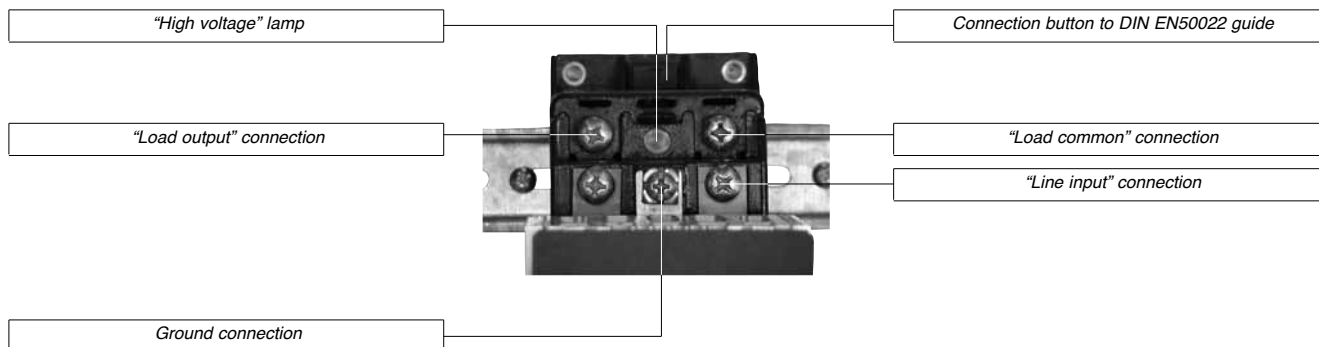

CONTROL

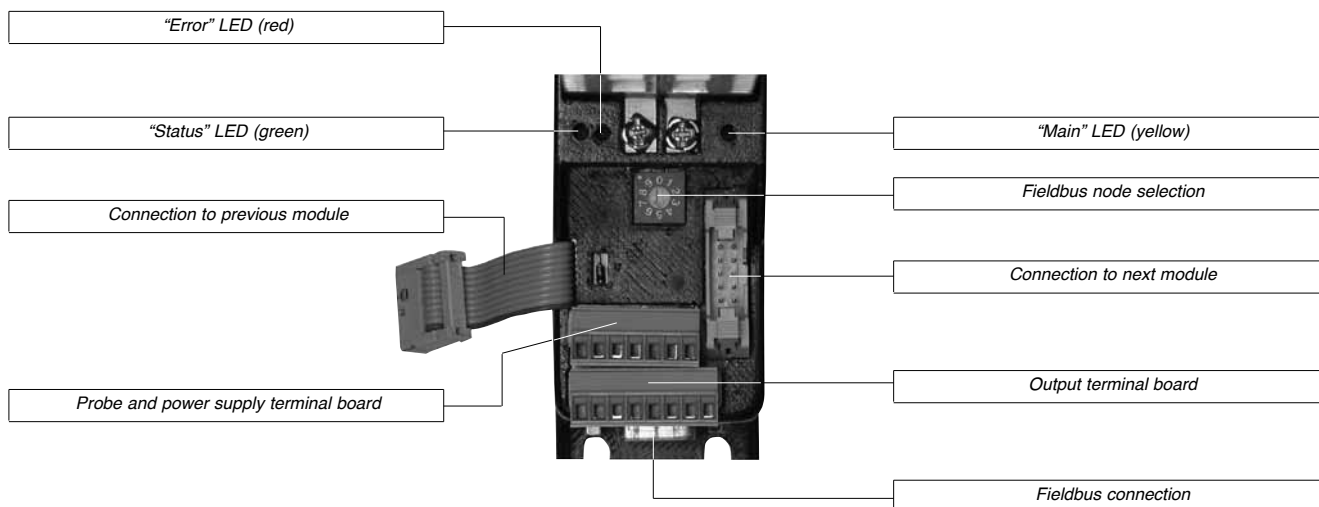

DISSIPATION CURVES

Rated current curves based on room temperature.

Geflex 25

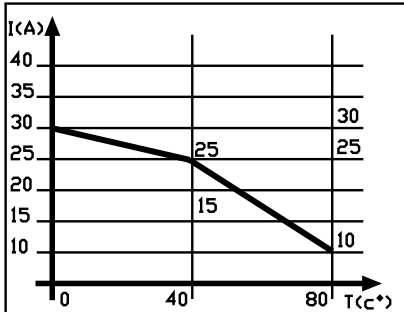

Geflex 40

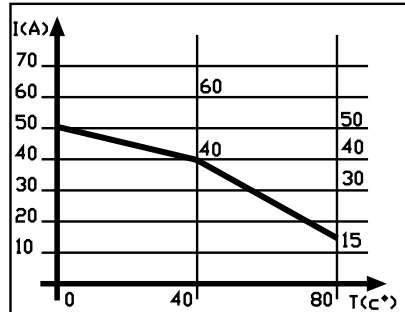

Geflex 60

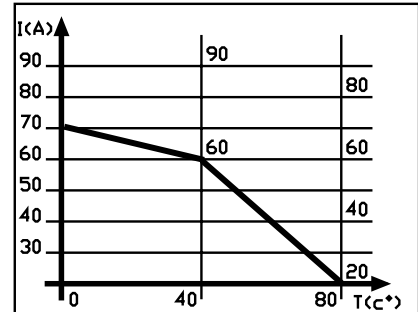

Geflex 75

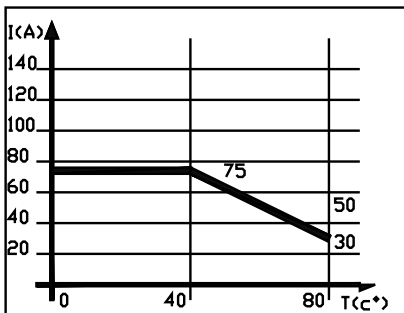

Geflex 90

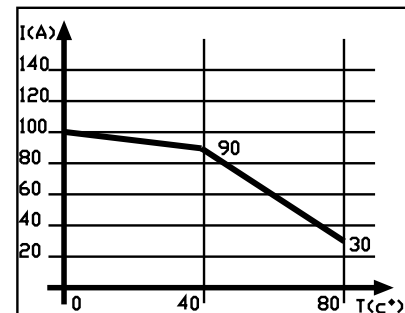

Geflex 120

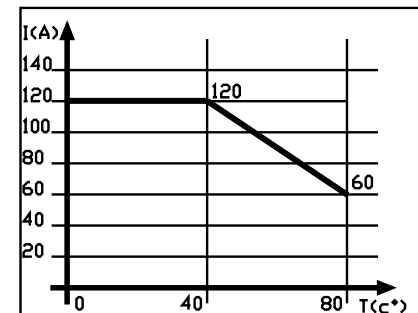

Dissipated Thermal Power:
 $P_{ds} = 1.6 \times I_{rms} \text{ (W)}$
 I_{rms} = rated current of single-phase load

N.B.: Geflex 120 curves refer to the device complete with standard fan running.

TABLE FOR SELECTION OF WIRE TERMINALS FOR POWER AND SIGNAL TERMINAL BOARDS

	Level	Terminal contact area (LxD)	Terminal hole diameter	Recommended conductor section
POWER	25A	12 x 12mm	5mm	6mm ²
	40A	12 x 12mm	5mm	10mm ²
	60A	14 x 12mm	6mm	16mm ²
	75A-90A	14 x 12mm	6mm	25mm ²
	120A	14 x 12mm	6mm	35mm ²
SIGNAL	Flexible wire conductor		Conductor with prod terminal with insulating collar	
	0.14 - 1.5mm ² / 28-16AWG		0.25 - 0.5mm ² / 24-20AWG	
	Cross-cut screwdriver, blade 0.4 x 2.5mm			

TYPE OF OPERATION

Zero Crossing switching

Command from logic output in voltage

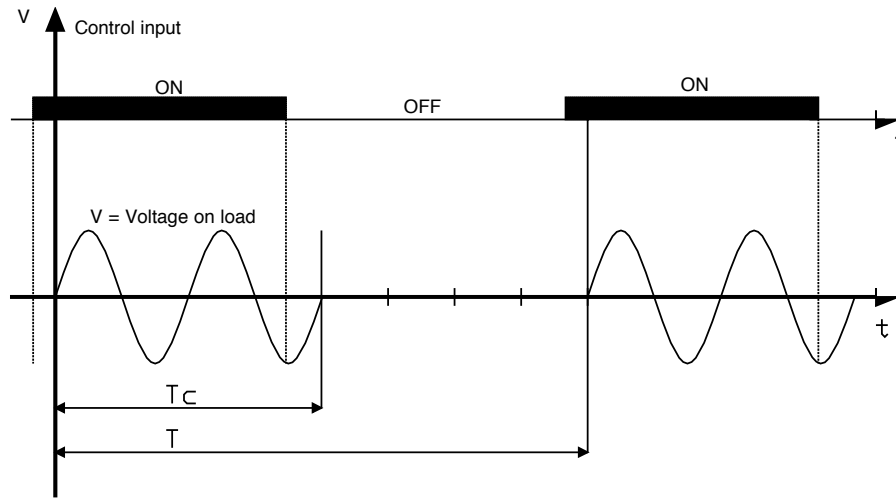

$$\text{Power delivered} = \text{Installed power} \times T_C / T$$

DIMENSIONS AND CUTOUT

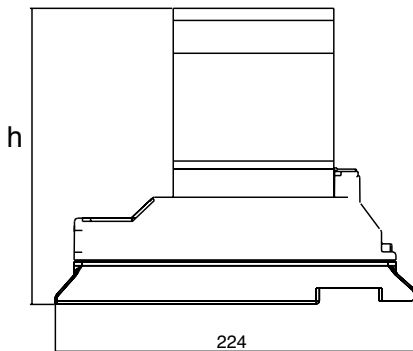

	h (mm)
25A	160
40A ... 120A	195

25/40A

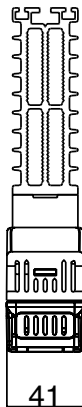

60A

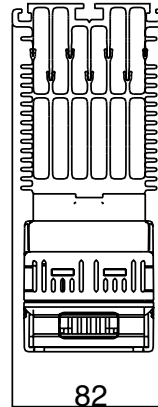

90/120A

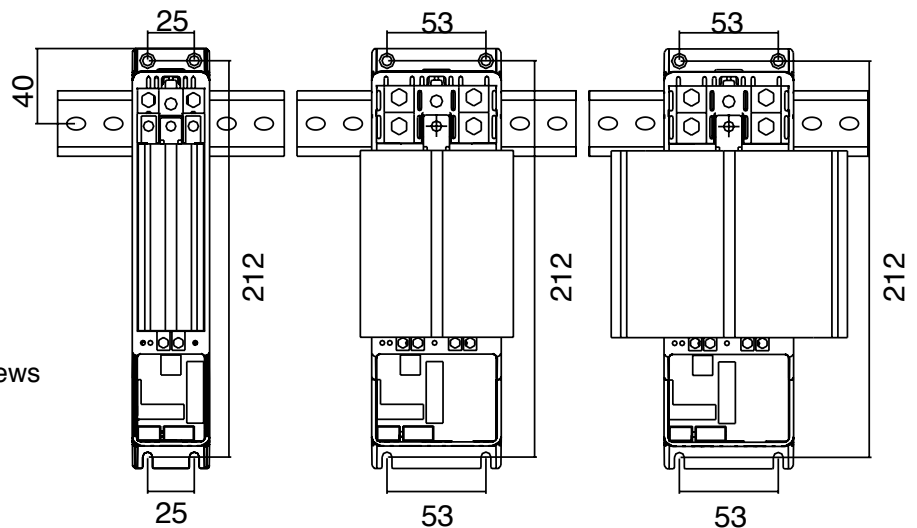
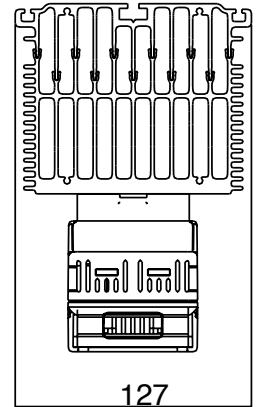

Installation on electromagnetic plate by means of quick coupling to DIN EN50022 guide or with 5MA screws (see TEMPLATE)

CONNECTION EXAMPLES

Connection of MASTER + SLAVE modules

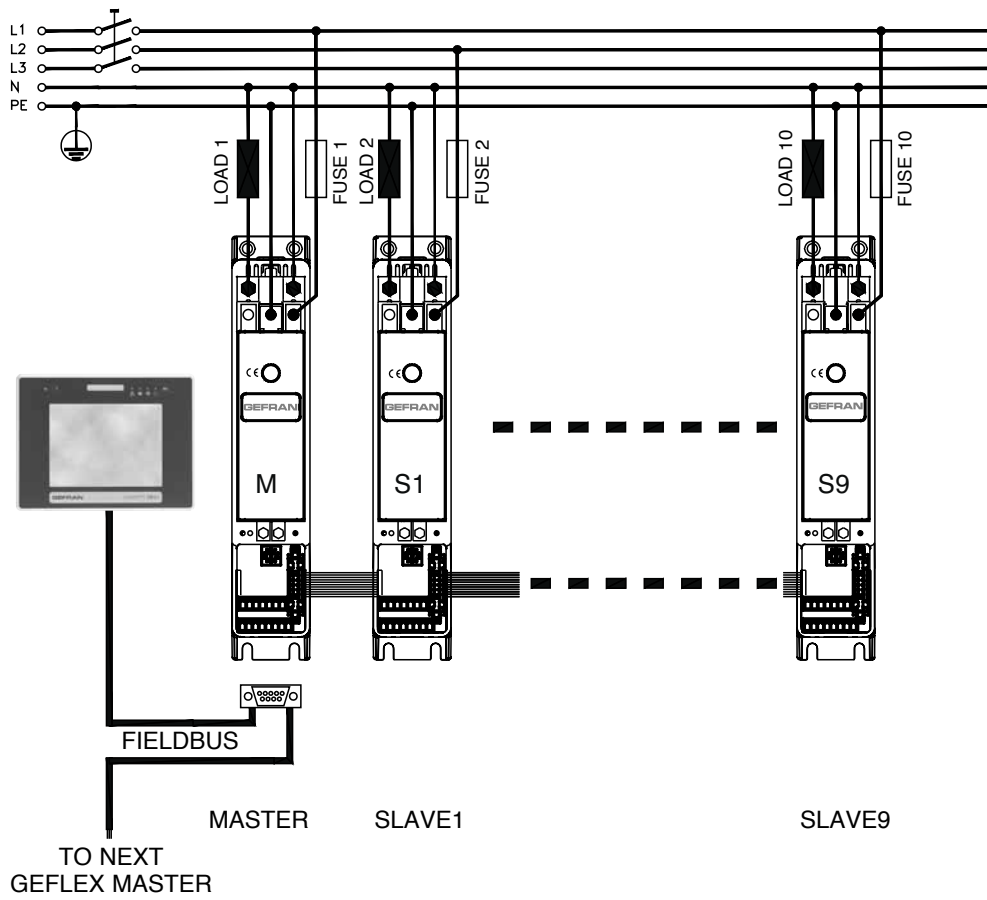

Three-phase connection

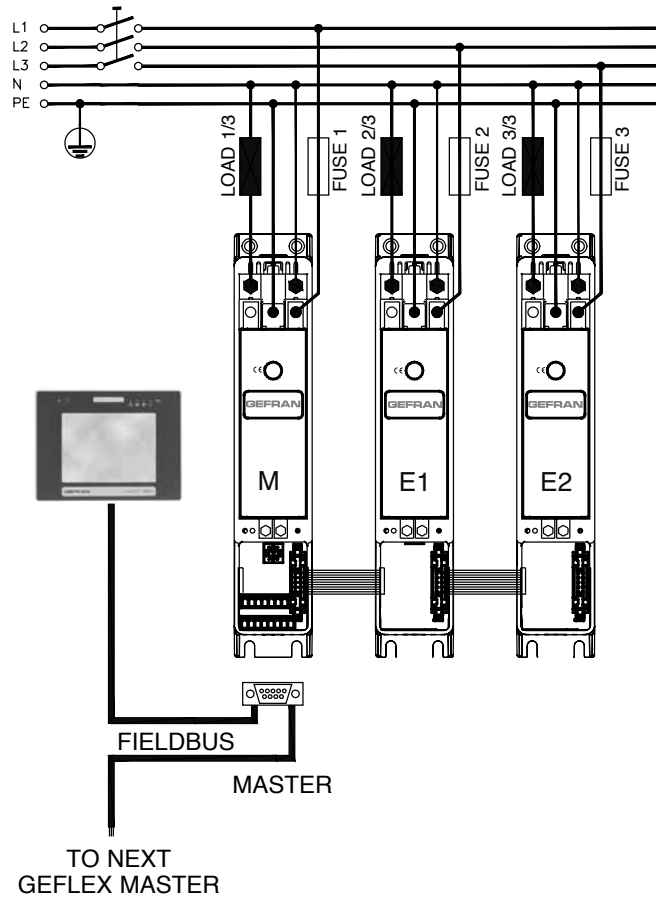

ELECTRICAL CONNECTIONS

Digital communication "PROFIBUS DP"

D-SUB connector 9-pin Male

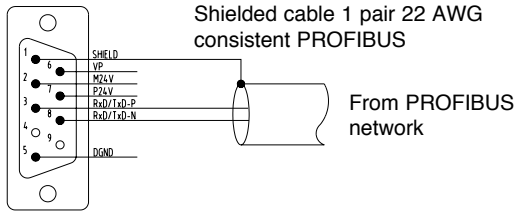

We advise you to connect a 220Ω 1/4W resistance between the "RxD/TxD-P" and "RxD/TxD-N" signals, a 390Ω 1/4W resistance between the "RxD/TxD-P" and "Vp" signals, and a 390Ω 1/4W resistance between the "RxD/TxD-N" and "DGND" signals at both ends of the Profibus network.

Digital communication "CANopen"

D-SUB Connector 9 pin Female

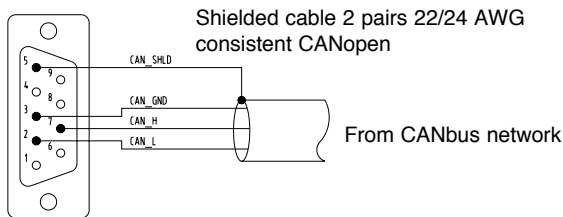

We advise you to connect a 124Ω 1/4W resistance between the "CAN_L" and "CAN_H" signals at both ends of the CANbus network.

Digital communication "MODBUS"

D-SUB Connector 9-pin Male

Shielded cable 1 pair 22 AWG consistent MODBUS

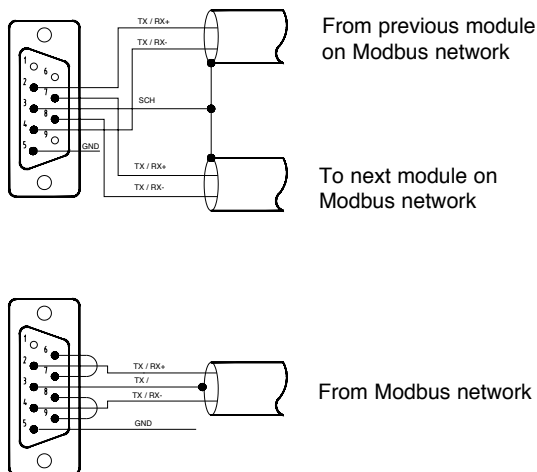

We advise you to connect pins 6 to 7 and pins 8 to 9 on the connector of the last Geflex on the Modbus network to insert the line termination.

We advise you to also connect the "GND" signal among Modbus devices having a line distance > 100 m.

Digital communication "DeviceNet"

Connector 5 pin

Shielded cable 2 pairs 22/24 AWG DeviceNet conformity

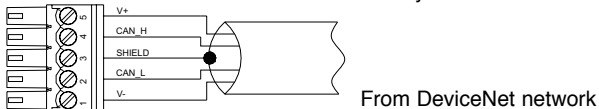

We advise you to connect a 120Ω 1/4W resistance between the "CAN_L" and "CAN_H" signals at both ends of the DeviceNet network.

Power

Three-phase line with neutral

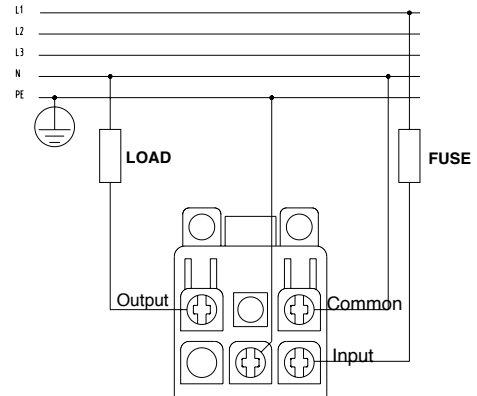

Three-phase line without neutral

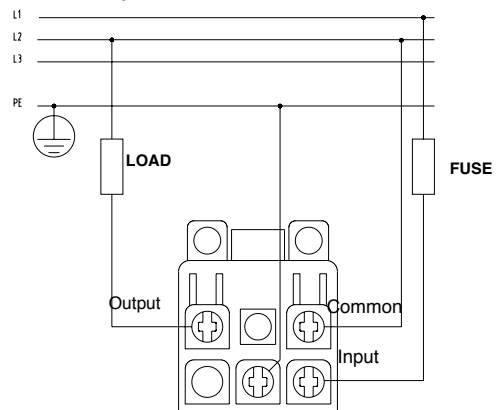

The **Input** and **Common** connection to the network depend on the application.

A wire with 0.5mm² / 20AWG section is sufficient for the Common connection.

Control

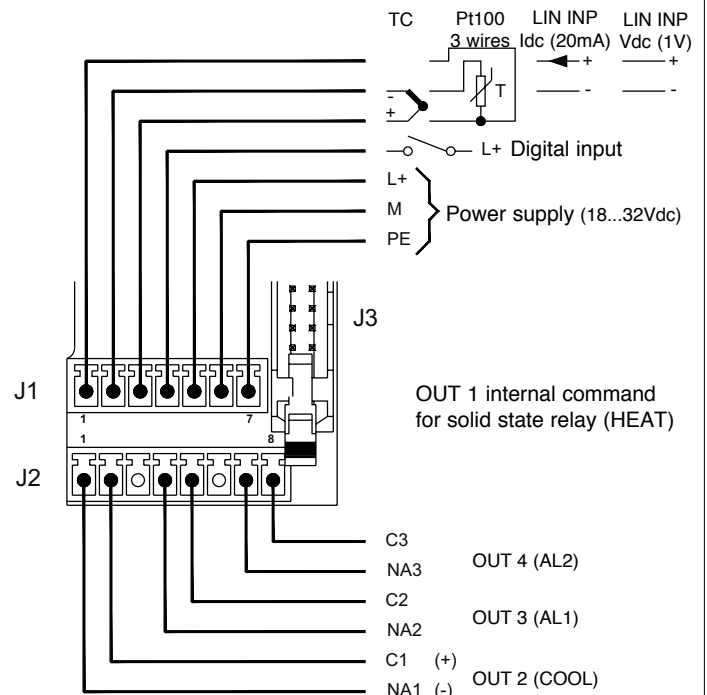

Legend

J1: Probe and power supply terminal board

J2: Relay output terminal board

J3: Connection among modules

(Logic output PNP18... 32Vdc optional not isolated from power supply)

ORDER CODE

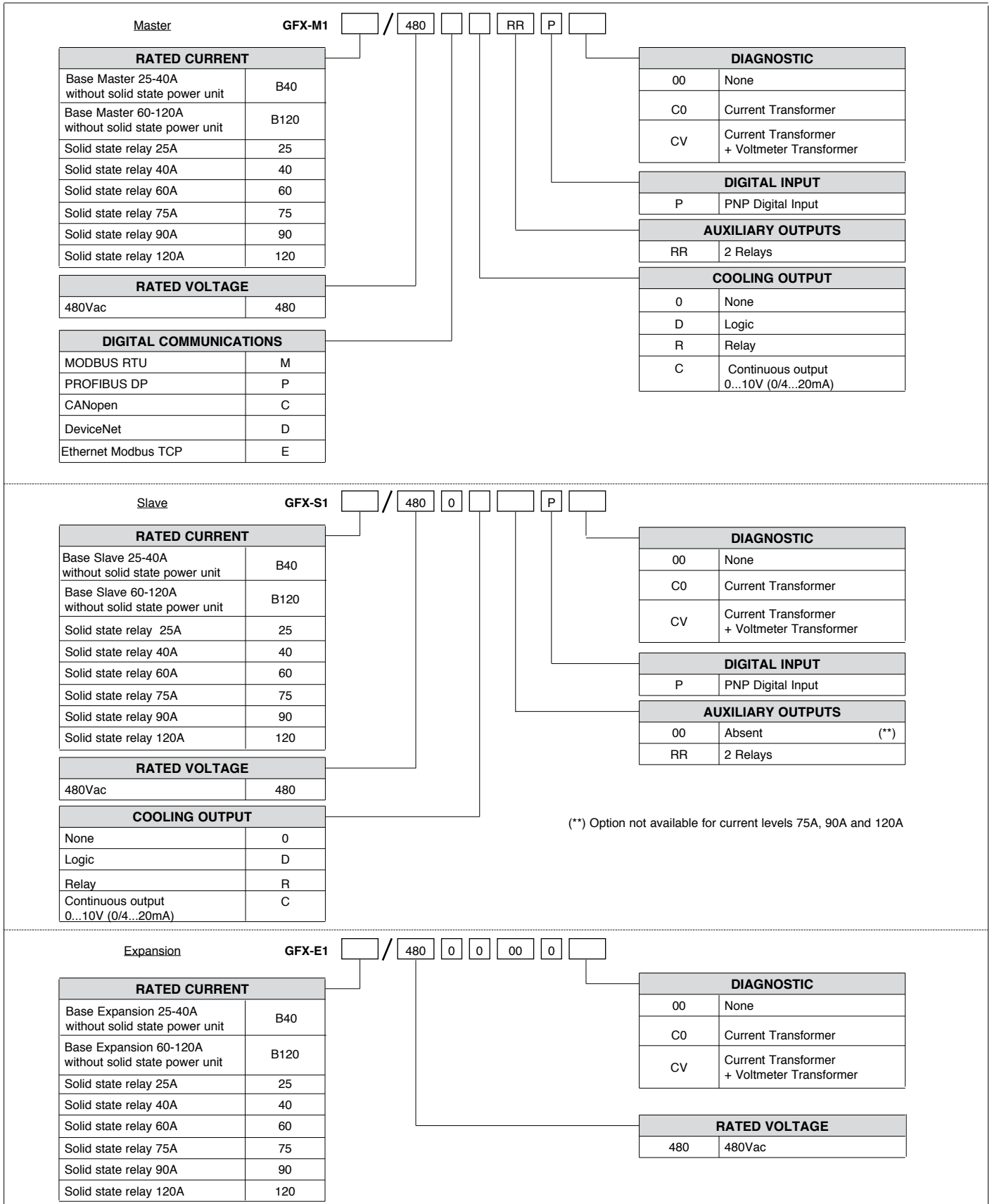

GEFRAN spa reserves the right to make aesthetic or functional changes at any time and without notice.

	Conformity C/UL/US File no. C/UL/US File no. E198546
	The instrument conforms to the European Directives 2004/108/CE and 2006/95/CE with reference to the generic standards : EN 61326-1 EN (product), EN 61010-1 (safety)