



### Main characteristics

- ONDA technology
- Optimised mechanical structure
- Strokes from 50 to 4000 mm
- Fast installation by mean of steel brackets
- Sliding or floating magnetic cursor
- Synchronous Serial Interface direct to controllers
- Output data resolution available from 1 to 40  $\mu\text{m}$
- Data format: binary or Gray code; incremental/ decremental
- Power supply 10...32 Vdc
- Resistance to vibration (DIN IEC68T2/6 12g)
- IP67 protection
- Work temperature: -30...+90°C

Contactless linear position transducer with ONDA magnetostrictive technology, with RS422-SSI digital output interface.

The absence of electrical contact on the cursor eliminates all wear and guarantees almost unlimited life.

Compact size for simple installation.

Full protection against outside agents for use in harsh environments with high contamination and presence of dust.

Excellent linearity, repeatability, resistance to mechanical vibrations and shocks.

### TECHNICAL DATA

Model	from 50 to 4000 mm
Measurement taken	displacement
Position read sampling time (typical)	1 ms
Shock test DIN IEC68T2-27	100g - 11ms - singolo colpo
Vibrations DIN IEC68T2-6	12g / 10...2000Hz
Displacement speed	$\leq 10$ m/s
Max. acceleration	$\leq 100$ m/s <sup>2</sup> spostamento
Output data resolution available	1, 2, 5, 10, 20, 40 $\mu\text{m}$
Cursor (see note)	Sliding cursor Floating separate cursor
Working temperature	-30...+90°C
Storage temperature	-40...+100°C
Coefficient of temperature	20 ppm FS / °C
Protection	IP67

Note 1) For stroke > 2500mm use sliding or floating cursors with max. distance of 4mm

### ELECTRICAL DATA

Output signal	Synchronous Serial (SSI); Binary/Gray; Incremental/Decremental
Data length	24 - 25 bit
Nominal power supply	10...32 Vdc
Max. power ripple	1Vpp
Max. input	50mA
Output load	RS422/485 standard
Electrical isolation	500V (*) (D.C. supply/earth)
Protection against polarity inversion	Yes
Protection against overvoltage	Yes
Self-resetting internal fuse	Yes

(\*) it includes a 50V 2J voltage suppressor

### MECHANICAL DIMENSIONS

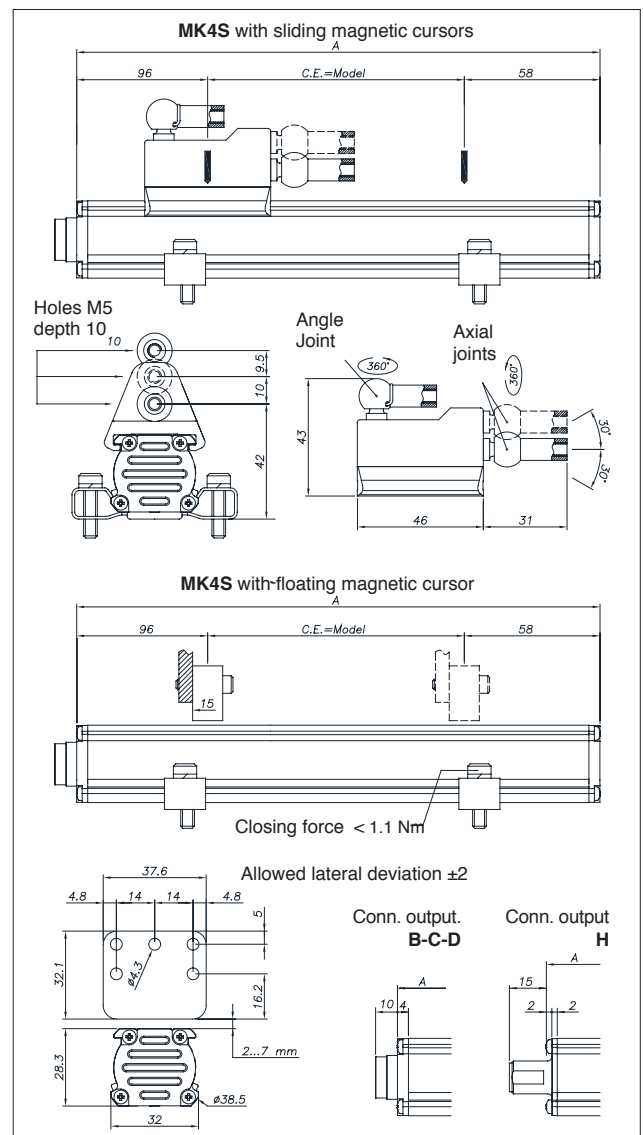

## ELECTRICAL / MECHANICAL DATA

Model	50 75 100 130 150 175 200 225 250 300 350 360 400 450 500 550 600 650 700 750 800 850 900 950 1000 1100 1200 1250 1300 1400 1500	
	1750 2000 2250 2500 2750 3000 3250 3500 3750 4000	
Electrical stroke (E.S.)	mm	Model
Independent linearity	± %F.S.	Typical : $\leq \pm 0,01$ %FS (min $\pm 0,060$ mm) with sliding cursor Typical : $\leq \pm 0.02$ % FS with floating cursor (value depending on the distance between the cursor and the sensor body)
Max. dimensions (A)	mm	Model + 154 mm
Repeatability	mm	< 0,01 (limited by the resolution of the output value)
Hysteresis		< $\pm 0,005$ % FS (min 0,010 mm)
Sampling time	ms	1 (for stroke from 1000) 2 (for stroke from 1100 to 2000) 4 (for stroke >2000)

## ELECTRICAL CONNECTIONS

OUTPUT MK4S B

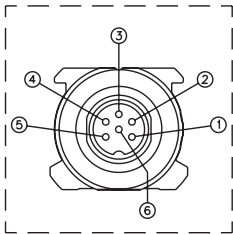

OUTPUT MK4S C

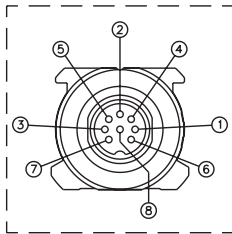

OUTPUT MK4S D

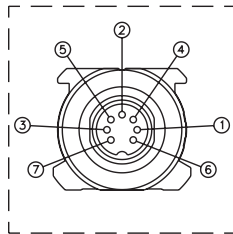

OUTPUT MK4S H

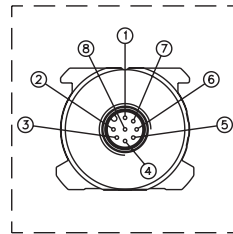

OUTPUT MK4S F/R

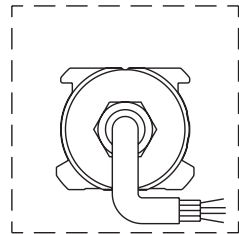

Function	MK4S B	MK4S C	MK4S D	MK4S H	MK4S F	MK4S R	CAV00X
	6-pin M16	8-pin M16	7-pin M16	8-pin M12	Cable output	PUR cable output	Optional 8-pin cable
Data -	1	5	1	5	Orange	Pink	Green
Data +	2	2	2	2	Orange / White	Blue	Gray
Clock +	3	1	3	3	Green / White	Gray	Pink
Clock -	4	3	4	1	Green	Yellow	Yellow
Power supply +	5	7	5	7	Blue / White	Green	Brown
Power supply GND	6	6	6	6	Blue	Brown	Blue
n.c.	-	8	7	8	-	-	White
n.c.	-	4	-	4	-	-	Red

The transducer case must be grounded with the cable sheathing on the control system side only.

## ORDER CODE

Position transducer

M K 4 S B

SSI digital output S

### Connector

DIN45322 6-pin connector output B

*Available on request*

DIN45326 8-pin connector output C

DIN45329 7-pin connector output D

M12 8-pin connector output H

Cable output PVC 6-pin (1 meter) F

Cable output PUR high flexibility 7-pin 7x0,14 R

### Model

### Output

Binary data code output B

Gray data code output G

### Data length

Data length 24 bit 3

Data length 25 bit 4

Data length 21+1 bit (FM357) 5

0 0 0 0 X X X X X 0 X X

### Data resolution

0.002 mm 0

0.005 mm (standard) 1

0.010 mm 2

0.020 mm 3

0.040 mm 4

0.001 mm 5

### Scale orientation

Ascending (standard) 1

Descending 2

Ascending (over sampling refresh output 4 KHz) 4

### Outputs

Outputs B, C, H 00

### F outputs cables length

1 meter (standard) 00

2 meters 02

3 meters 03

4 meters 04

5 meters 05

10 meters 10

15 meters 15

Mechanical and/or electrical characteristics differing from those in the standard version may be arranged on request

Ex.: MK4-S-B-0400-B-3, 0000-X-X-1-1-X-00-X-0-XX

Transducer model MK4, SSI output, connector B, model 400, binary data code output, data length 24 bit, system resolution 0.005mm, scale orientation ascending.

## CURSORS ON REQUEST

P C U R 0 1

### Cursors

Sliding cursor, axial joint (low) (STANDARD) 035

Sliding cursor, axial joint (high) 036

Sliding cursor, angle joint 037

Floating cursor 039

Number of cursors

PCUR035

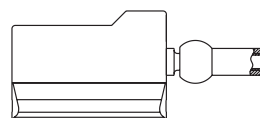

PCUR036

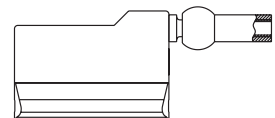

PCUR037

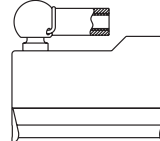

PCUR039

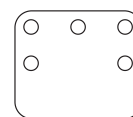

## BRACKETS ON REQUEST

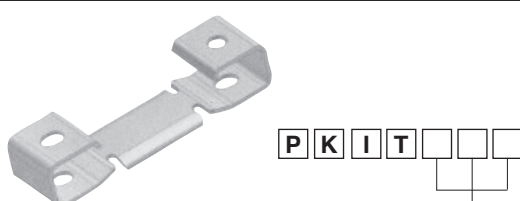

Brackets (2 brackets for every kit)	
Steel bracket, center distance 42.5mm	<b>090</b>
Steel bracket, center distance 50mm	<b>091</b>

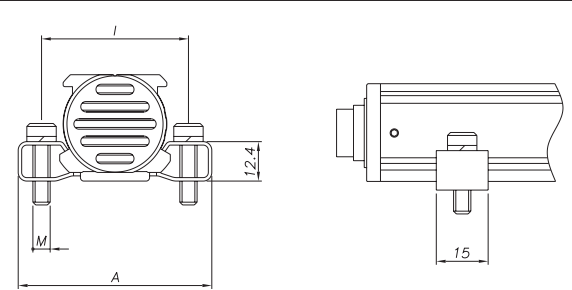

Brackets code	Center distance (l)	Screw (V)	Dimensions (A)
PKIT090	42.5	<b>M4</b>	<b>56</b>
PKIT091	50	<b>M5</b>	<b>63.5</b>

## OPTIONAL CONNECTORS

For output H, M12 connector thread

Codes: **CON035** for 8-pin output (MK4S H)  
**CON042** for 8-pin output (MK4S H)

For outputs B-C-D, M16 connector thread

Codes: **CON021** for 6-pin output (MK4S B)  
**CON022** for 6-pin output (MK4S B)  
**CON023** for 6-pin output (MK4S B)  
**CON026** for 8-pin output (MK4S /D)  
**CON027** for 8-pin output (MK4S /D)  
**CON028** for 8-pin output (MK4S /D)

Connector extraction length 10 mm

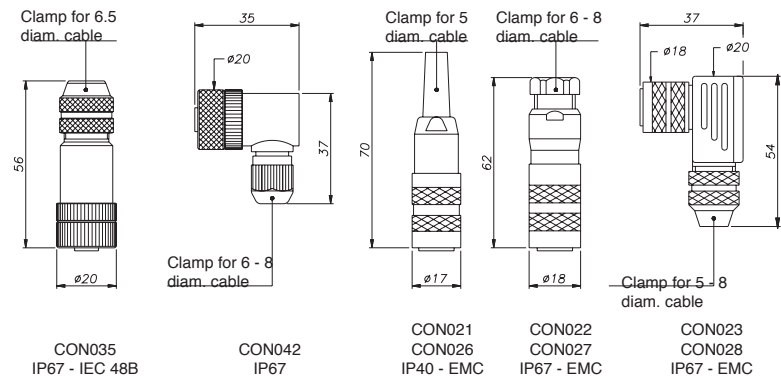

## OPTIONAL CABLES OUTPUT H

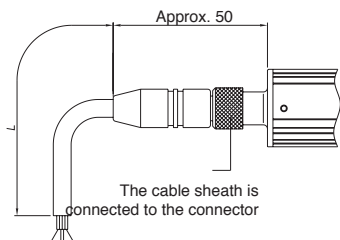

**PREWIRED CABLE WITH STRAIGHT CONNECTOR**

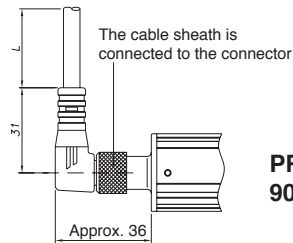

**PREWIRED CABLE WITH 90° CONNECTOR**

Code for 8-pin cable		MK4S - H	
Length "L"		CODE	
		Straight cable	90° cable
2	mt	<b>CAV002</b>	<b>CAV005</b>
5	mt	<b>CAV003</b>	<b>CAV006</b>
10	mt	<b>CAV004</b>	<b>CAV007</b>
15	mt	<b>CAV009</b>	<b>CAV008</b>

Sensors are manufactured in compliance with:

- EMC 2014/30/EU compatibility directive
- RoHS 2011/65/EU directive

Electrical installation requirements and Conformity certificate are available on our web site: [www.gefran.com](http://www.gefran.com)

**GEFRAN spa** reserves the right to make aesthetic or functional changes at any time and without notice

**GEFRAN**

**GEFRAN spa**

via Sebina, 74 - 25050 PROVAGLIO D'ISEO (BS) - ITALIA

ph. 0309888.1 - fax. 0309839063 Internet: <http://www.gefran.com>

DTs\_MK4S-ONDA\_04-2016\_ENG