

2008

AC Inverter • Compact V/f

SIEDrive ADV20



Big Performance Small Size.

English

GEFRAN

SIEDrive ADV20 Series

➔ Power range

AC mains supply	Power range ADV20 kW (Hp)				
	0.4 (0.5)	0.75 (1.0)	1.5 (2.0)	2.2 (3.0)	3.7 (5.0)
115 Vac, 1 phase	Size 1	Size 2			
230 Vac, 1 phase	Size 1		Size 2		
460 Vac, 3 phase	Size 1		Size 2		

➔ Side-by-side installation

High efficiency cooling and flexible space.



40°C Tamb. max.

➔ ADV20 PC Tool Configurator

ADV20 can be programmed by the use of the PC, integrated functions: programming through parameter list, Integrated oscilloscope, Trend recorder, Saving/ Loading and comparing parameters.

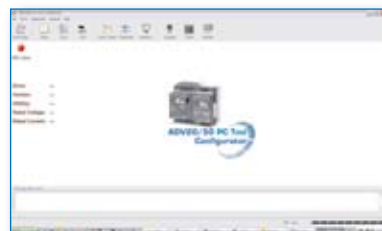

Variable speed AC Motor Drive

➤ Compact design

Space saving and easy DIN rail mounting with DIN rail adapter (Built in size 2, Optional for Size 1).

➤ Built-in EMC filter

On 230V 1-phase and 400-460V 3-phase models. To reduce electromagnetic interference efficiently it was applied EN61800-3.

➤ Complete protection function

High precision current detection, full overload protection, over-voltage/over-current stall prevention, short-circuit protection, reset after fault, speed search function and motor overheat protection by PTC.



➤ Optional fieldbus modules

Provide connection to a variety of networks, including PROFIBUS, DeviceNet, LonWorks and CANopen.



CANopen



➤ Standard MODBUS protocol

Standard MODBUS Protocol via RS-485 (RJ-45).

➤ RFI-Jumper for IT mains

Removable "Y" capacitor for use on IT mains supplies

➤ Easy DC BUS sharing

Multiple ADV20 can be connected in parallel to share the regenerative braking energy. In this way, over-voltage is prevented and the DC-bus voltage stabilized.

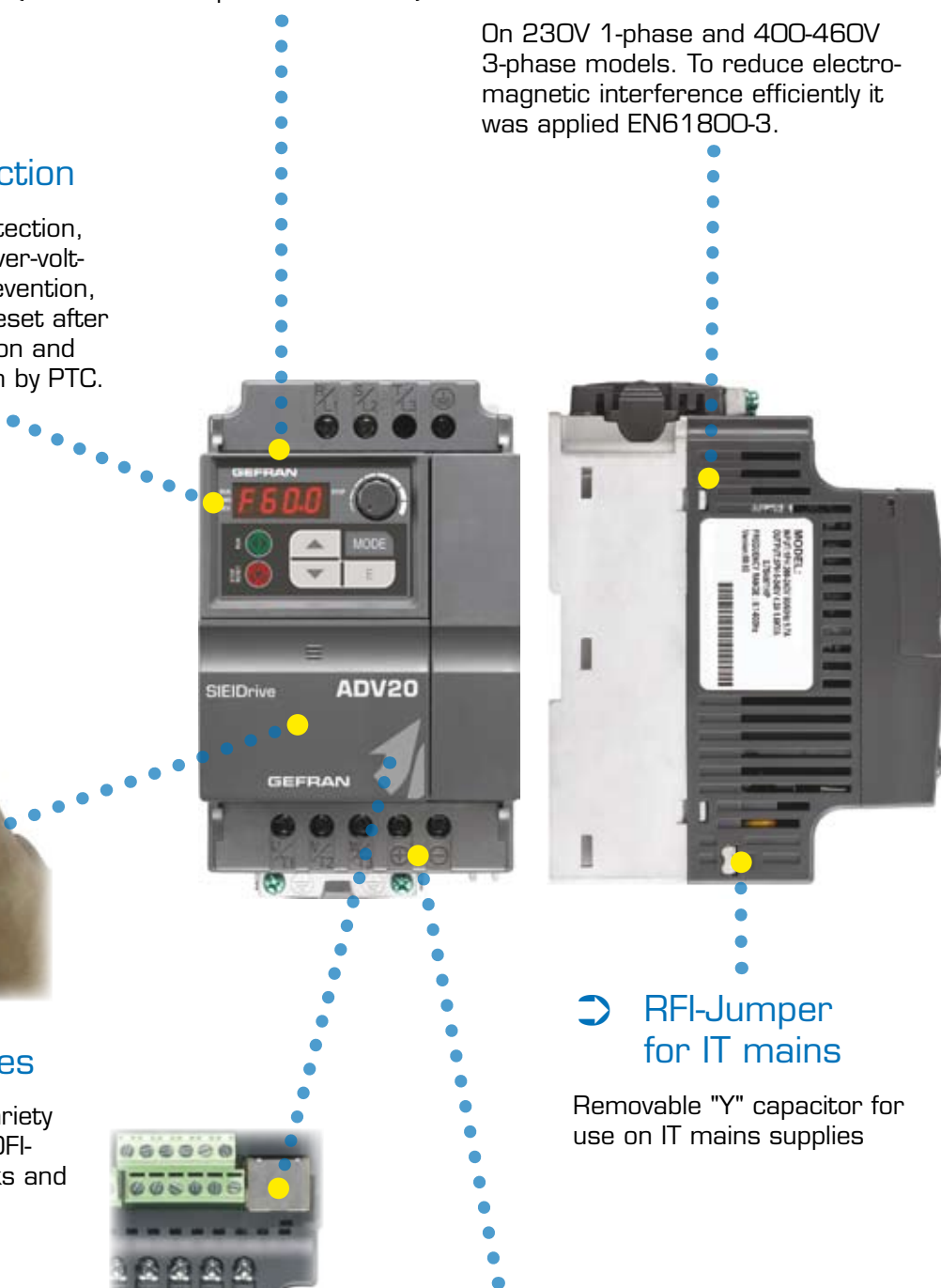

SIEIDrive ADV20 Series

➤ Figure 1 for ADV20-...-1M/2M series

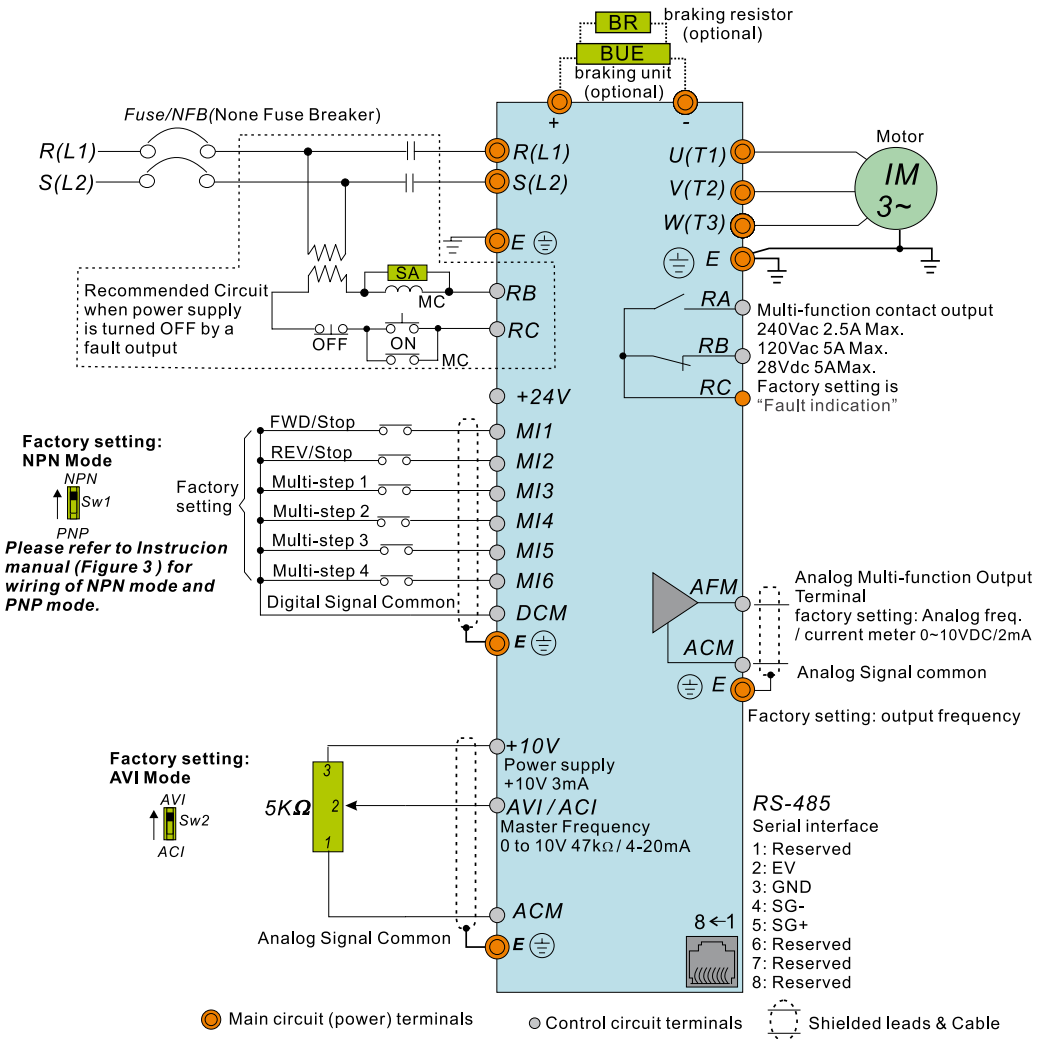

➤ External / Internal parts

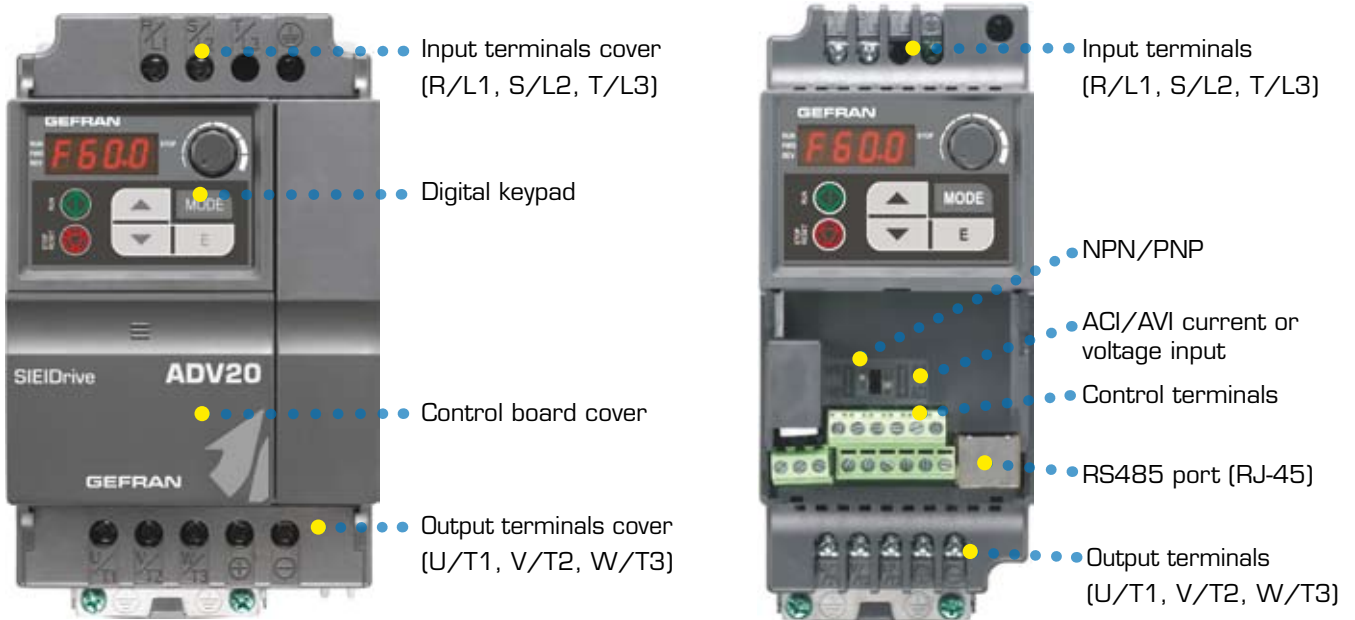

Variable speed AC Motor Drive



Conveyor and Transportation Machinery

- Conveyor belt
- Automatic doors
- Roller door
- Small elevator
- Escalator
- Parking device
- X-Y axis of travelling crane



Food Processing

- Dumpling maker
- Food stirrer
- Noodle maker



Machine Tool/Metal Processing Machinery

- Grinder
- Drill
- Small lathe
- Milling machines
- Injection molding (clamp)



Wood working machinery

- 4 side planer
- Woodcarver
- Wood working machine
- Simple cutting machine for wood working
- Spraying machine



HVAC and Pump Systems

- Building air conditioner
- Wastewater processing system
- Constant pressure water treatment system
- Water treatment pump
- Agricultural pump
- Temperature control of middle/large oven
- Air compressor
- Heat exchange fans
- Building water dispenser system
- Dryer's windmill



Paper/Textile Machine

- Round weaver
- Cross weaver
- Ribbon weaver
- Printing press
- Industrial sewing machine
- Knitting machines

Others

- Ironing machine
- Pulverizer
- Treadmill
- Feeder
- Industrial washing machine
- Car washing machine
- Packing machine
- Centrifuge
- Liquid mixer

SIEDrive ADV20 Series

Specifications

Voltage Class		115V Class		
Model Number ADV20-XXXX			1004	2007
Output Rating	Max. Applicable Motor Output	kW	0.4	0.75
	Max. Applicable Motor Output	Hp	0.5	1.0
	Rated Output Capacity	kVA	1.0	1.6
	Rated Output Current	A	2.5	4.2
	Maximum Output Voltage	V	3-Phase Proportional to Twice the Input Voltage	
	Output Frequency	Hz	0.1~600 Hz	
	Carrier Frequency	kHz	2-12	
Input Rating	Rated Input Current	A	9	18
	Rated Voltage/Frequency	V / Hz	Single phase, 100-120V, 50/60Hz	
	Voltage Tolerance		± 10% (90~132 V)	
	Frequency Tolerance		± 5% (47~63Hz)	
Cooling Method		Natural Cooling		
Weight	kg		1.1	1.4

Voltage Class		230V Class				
Model Number ADV20-XXXX			1004	1007	2015	2022
Output Rating	Max. Applicable Motor Output	kW	0.4	0.75	1.5	2.2
	Max. Applicable Motor Output	Hp	0.5	1.0	2.0	3.0
	Rated Output Capacity	kVA	1.0	1.6	2.9	4.2
	Rated Output Current	A	2.5	4.2	7.5	11.0
	Maximum Output Voltage	V	3-Phase Proportional to Input Voltage			
	Output Frequency	Hz	0.1~600 Hz			
	Carrier Frequency	kHz	2-12			
Input Rating	Rated Input Current (1-phase)	A	6.5	9.5	15.7	24
	Rated Voltage/Frequency	V / Hz	1-phase, 200-240 V, 50/60Hz			
	Voltage Tolerance		±10%(180~264 V)			
	Frequency Tolerance		± 5% (47~63Hz)			
Cooling Method		Natural Cooling	Fan Cooling			
Weight	kg	1.2	1.2	1.7	1.7	

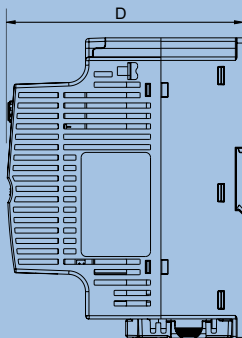
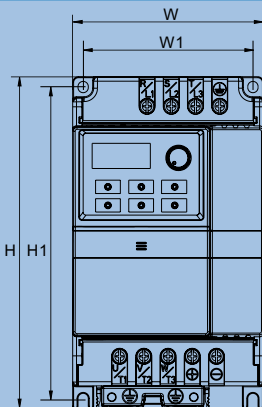

Voltage Class		460V Class					
Model Number ADV20-XXXX			1004	1007	1015	2022	2037
Output Rating	Max. Applicable Motor Output	kW	0.4	0.75	1.5	2.2	3.7
	Max. Applicable Motor Output	Hp	0.5	1.0	2.0	3.0	5.0
	Rated Output Capacity	kVA	1.2	2.0	3.3	4.4	6.8
	Rated Output Current	A	1.5	2.5	4.2	5.5	8.2
	Maximum Output Voltage	V	3-Phase Proportional to Input Voltage				
	Output Frequency	Hz	0.1~600 Hz				
	Carrier Frequency	kHz	2-12				
Input Rating	Rated Input Current	A	1.8	3.2	4.3	7.1	9.0
	Rated Voltage/Frequency	V / Hz	3-phase, 380-480V, 50/60Hz				
	Voltage Tolerance		±10% (342~528V)				
	Frequency Tolerance		± 5% (47~63Hz)				
Cooling Method		Natural Cooling		Fan Cooling			
Weight	kg	1.2	1.2	1.2	1.7	1.7	

Dimensions - mm [inches]



Size	W	W1	H	H1	D	Ø	Ø D
1	72.0 [2.83]	59.0 [2.32]	174.0 [6.86]	151.6 [5.97]	136.0 [5.36]	5.4 [0.21]	2.7 [0.11]
2	100.0 [3.94]	89.0 [3.50]	174.0 [6.86]	162.9 [6.42]	136.0 [5.36]	5.4 [0.21]	2.7 [0.11]

Variable speed AC Motor Drive

General Specifications			
Control Characteristics	Control System		SPWM (Sinusoidal Pulse Width Modulation) control (V/f control)
	Frequency Setting Resolution		0.01Hz
	Output Frequency Resolution		0.01Hz
	Torque Characteristics		Including the auto-torque/auto-slip compensation; starting torque can be 150% at 5.0Hz
	Overload Endurance		150% of rated current for 1 minute
	Skip Frequency		Three zones, setting range 0.1-600Hz
	Accel/Decel Time		0.1 to 600 seconds (2 Independent settings for Accel/Decel time)
	Stall Prevention Level		Setting 20 to 250% of rated current
	DC Braking		Operation frequency 0.1-600.0Hz, output 0-100% rated current Start time 0-60 seconds, stop time 0-60 seconds
	Regenerated Braking Torque		Approx. 20% (up to 125% possible with optional brake resistor or externally mounted brake unit)
	V/f Pattern		Adjustable V/f pattern
Operating Characteristics	Frequency Setting	Keypad	Setting by ▲ ▼
		External Signal	Potentiometer-5kΩ/0.5W, 0 to +10VDC, 4 to 20mA, RS-485 interface; Multi-function Inputs 3 to 6 (15 steps, Jog, motopotentiometer)
	Operation Setting Signal	Keypad	Set by RUN and STOP
		External Signal	2 wires/3 wires (MI1, MI2, MI3), JOG operation, RS-485 serial interface (MODBUS), programmable logic controller
	Multi-function Input Signal		Multistep selection 0 to 15, Jog, accel/decel inhibit, 2 accel/decel switches, counter, external Base Block, ACI/AVI selections, driver reset, UP/DOWN key settings, NPN/PNP input selection
	Multi-function Output Indication		AC drive operating, frequency attained, non-zero frequency, zero speed, Base Block, fault indication, local-remote indication, drive is ready, overheat alarm, emergency stop and status selections of input terminals
	Analog Output Signal		Output frequency/current
	Alarm Output Contact		Contact will be On when drive malfunctions (1 Form C/change-over contact)
	Operation Functions		AVR, accel/decel S-Curve, over-voltage/over-current stall prevention, 5 fault records, reverse inhibition, momentary power loss restart, DC braking, auto torque/slip compensation, auto tuning, adjustable carrier frequency, output frequency limits, parameter lock/reset, PID control, external counter, MODBUS communication, abnormal reset, abnormal re-start, power-saving, fan control, sleep/wake frequency, 1st/2nd frequency source selections, 1st/2nd frequency source combination, NPN/PNP selection
	Protection Functions		Over voltage, over current, under voltage, external fault, overload, ground fault, overheating, electronic thermal, IGBT short circuit, PTC
Display Keypad		6-key, 7-segment LED with 4-digit, 4 status LEDs, master frequency, output frequency, output current, custom units, parameter values for setup and lock, faults, RUN, STOP, RESET, FWD/REV	
Built-in EMC Filter		- 230V, 1phase models: EN61800-3: 2004 C1 8kHz for motor cable lengths ≤1m and EN61800-3:2004 C2 8kHz for motor cable lengths ≤5m - 400-460V/3phase models: EN61800-3:2004 C3 8kHz for motor cable lengths ≤15m	
Environmental Conditions	Enclosure Rating		IP20
	Pollution Degree		2
	Installation Location		Altitude 1,000 m or lower, keep from corrosive gasses, liquid and dust
	Ambient Temperature		-10°C to 50°C (40°C for side-by-side mounting), non-condensing and not frozen
	Storage/ Transportation Temperature		-20 °C to 60 °C
	Ambient Humidity		Below 90% RH (non-condensing)
	Vibration		9.80665m/s ² (1G) less than 20Hz, 5.88m/s ² (0.6G) at 20 to 50Hz
Approvals		  	

SIEDrive ADV20 Series

➔ Model explanation

ADV20 1007 - KXX - 4 F	
Drive ADV20 series	EMI Filter: F = included = not incl.
Mechanical drive sizes: 1 = size 1 (frame A) 2 = size 2 (frame B)	Rated voltage: 1M=115Vac, 1ph 2M=230Vac, 1ph 4=400-460 Vac, 3ph
Drive powers, in kW: 004 = 0.4 kW 007 = 0.75 kW 015 = 1.5 kW 022 = 2.2 kW 037 = 3.7kW	Software : X = standard
	Braking unit : X = not included B = included
	Keypad: X = not included K = included



➔ Drive models & codes

Models	Code	Description
115V Class - Single phase		
ADV20-1004-KXX-1M	S6D01	Size 1 - 0.4 kW - With keypad
ADV20-2007-KXX-1M	S6D02	Size 2 - 0.75 kW - With keypad
230V Class - Single phase		
ADV20-1004-KXX-2MF	S6D03	Size 1 - 0.4 kW - With keypad - EMC Filter included
ADV20-1007-KXX-2MF	S6D04	Size 1 - 0.75 kW - With keypad - EMC Filter included
ADV20-1015-KXX-2MF	S6D05	Size 2 - 1.5 kW - With keypad - EMC Filter included
ADV20-2022-KXX-2MF	S6D06	Size 2 - 2.2 kW - With keypad - EMC Filter included
400-460V Class - Three phase		
ADV20-1004-KXX-4F	S6D10	Size 1 - 0.4 kW - With keypad - EMC Filter included
ADV20-1007-KXX-4F	S6D11	Size 1 - 0.75 kW - With keypad - EMC Filter included
ADV20-1015-KXX-4F	S6D12	Size 1 - 1.5 kW - With keypad - EMC Filter included
ADV20-2022-KXX-4F	S6D13	Size 2 - 2.2 kW - With keypad - EMC Filter included
ADV20-2037-KXX-4F	S6D14	Size 2 - 3.7 kW - With keypad - EMC Filter included

Variable speed AC Motor Drive

➤ Accessories & Options

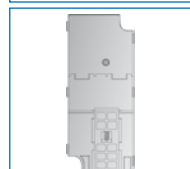

Models	Code	Description
EXP-DN-ADV20/50	S6D50	DeviceNet module
EXP-PDP-ADV20/50	S6D52	Profibus module
EXP-CAN-ADV20/50	S6D53	CANopen module
KIT DIN ADV20-SA	S6D55	DIN-rail adapter for ADV20 size 1
KIT EMC ADV20/50	S6D54	Earthing plate
USB-485-ADV20/50	S6D65	USB-RS485 RJ45 Converter
BU-2-ADV20/50	S6D70	Braking Unit 1.5kW 230V series
BU-4-ADV20/50	S6D71	Braking Unit 1.5kW 400V series

➤ Other options (on request only)

EXP-LWK-ADV20/50	S6D51	LonWorks module
BU-2A-ADV20/50	S6D72	Braking Unit 3.7kW 230V series
BU-4A-ADV20/50	S6D73	Braking Unit 3.7kW 400V series
RF-OUT-ADV20/50	S6D67	Zero Phase Reactor
Memory KB-ADV20/50	S6D66	Digital Keypad for parameters copy

➔ Braking Resistors

The table shows the combinations of braking resistors to be used exclusively with the relative external braking units. Values for standard resistors refer to a braking duty cycle of 10%.

Models	Brake Unit	Brake Resistors Model			Brake Res. Dimensions.
	Model (No. Units)	Model	Code	(No. Units)	Width x Height x Depth (Weight)
115V Class					
ADV20-1004-KXX-1M	BU-2-ADV20/50 (1)	RF220T 250R	S8T0CP	(1)	300 x 27 x 36 mm (500 g)
ADV20-2007-KXX-1M	BU-2-ADV20/50 (1)	RF220T 150R	S8T0CQ	(1)	300 x 27 x 36 mm (500 g)
230V Class					
ADV20-1004-KXX-2MF	BU-2-ADV20/50 (1)	RF220T 250R	S8T0CP	(1)	300 x 27 x 36 mm (500 g)
ADV20-1007-KXX-2MF	BU-2-ADV20/50 (1)	RF220T 150R	S8T0CQ	(1)	300 x 27 x 36 mm (500 g)
ADV20-2015-KXX-2MF	BU-2-ADV20/50 (1)	RF300DT 100R	S8T0CB	(1)	260 x 47 x 106 mm (1400 g)
ADV20-2022-KXX-2MF	BU-2A-ADV20/50 (1)	RF300DT 68R	S8T0CS	(1)	260 x 47 x 106 mm (1400 g)
460V Class					
ADV20-1004-KXX-4F	BU-4-ADV20/50 (1)	RF300DT 400R	S8T0CR	(1)	260 x 47 x 106 mm (1400 g)
ADV20-1007-KXX-4F	BU-4-ADV20/50 (1)	RF300DT 400R	S8T0CR	(1)	260 x 47 x 106 mm (1400 g)
ADV20-1015-KXX-4F	BU-4-ADV20/50 (1)	RF300DT 200R	S8T1DB	(1)	260 x 47 x 106 mm (1400 g)
ADV20-2022-KXX-4F	BU-4A-ADV20/50 (1)	RF300DT 150R	S8T0CT	(1)	260 x 47 x 106 mm (1400 g)
ADV20-2037-KXX-4F	BU-4A-ADV20/50 (1)	RFPD750DT 100R	S8SY4	(1)	200 x 70 x 106 mm (1700 g)

➔ Fuses

Following table shows the suggested fuses matching. Those fuses are not available in Gefran.





Models	Europe	America
	Fuse current (A) - Suggested type	Bussmann P/N (UL 508C)
115V Class		
ADV20-1004-KXX-1M	10 A, gR type	JJN-15
ADV20-2007-KXX-1M	32 A, gR type	JJN-30
230V Class		
ADV20-1004-KXX-2MF	10 A, gR type	JJN-15
ADV20-1007-KXX-2MF	16 A, gR type	JJN-20
ADV20-2015-KXX-2MF	25 A, gR type	JJN-30
ADV20-2022-KXX-2MF	40 A, gR type	JJN-50
460V Class		
ADV20-1004-KXX-4F	6 A, gR type	JJS-6
ADV20-1007-KXX-4F	6 A, gR type	JJS-6
ADV20-1015-KXX-4F	8 A, gR type	JJS-10
ADV20-2022-KXX-4F	12 A, gR type	JJS-15
ADV20-2037-KXX-4F	16 A, gR type	JJS-20

Drive & Motion Control Unit



➤ Inverters

				
ADV20 <ul style="list-style-type: none"> • V/f • 0.4... 3.7 kW • 110...120 Vac, 1ph • 200...240 Vac, 1ph • 380...480 Vac, 3ph 	ADV50 <ul style="list-style-type: none"> • V/f & Sensorless Vector • 0.4... 11 kW • 200...240 Vac, 1ph • 200...240 Vac, 3ph • 380...480 Vac, 3ph 	ADV200 <ul style="list-style-type: none"> • Vector Field Oriented • 0.75... 45 kW • 400 ... 480 Vac, 3ph 	AGy-EV <ul style="list-style-type: none"> • Torque Vector • 0.75 ... 200 kW • 230 ... 575 Vac, 3ph 	AVy <ul style="list-style-type: none"> • Flux Vector • 0.75 ... 630 kW • 230 ... 690 Vac, 3ph

➤ Inverters LIFT

				
AVMs <ul style="list-style-type: none"> • Roomless applications • Speed range up to 3m/s • Geared and gearless • From 5.5kW (7.5Hp) to 18.5kW (25Hp) 	AVRy <ul style="list-style-type: none"> • Built-in power recovery • Speed range up to 5m/s and beyond • Gearless • From 5.5 (7.5Hp) to 15kW (20Hp) 	Lift Drive System System complete with: <ul style="list-style-type: none"> • AVyL or AGyL drive • Internal EMC filter • Internal DC choke • Internal Output contactors • Emergency supply battery 	AGy LIFT <ul style="list-style-type: none"> • Sensorless Vector • Speed range up to 1.5m/s with closed loop • New installation and Retrofitting • 0.75 ... 160 kW 	AVy LIFT <ul style="list-style-type: none"> • Flux Vector • Speed range up to 5m/s and beyond • New installation and Retrofitting • 0.75 ... 160 kW

➤ Brushless

			
XVy-EV Servodrive <ul style="list-style-type: none"> • Brushless and Asynchronous • 1.5 ... 315 kW (2 ... 450 Hp) • 230 ... 480 Vac, 3ph 	SHJ Servomotors <ul style="list-style-type: none"> • 230Vac and 400Vac • 3000, 4000, 4500, 6000, 8000 rpm • from 0.33 to 3.8Nm 	SBM Servomotors <ul style="list-style-type: none"> • 400Vac • 1500, 2000, 3000 and 4000 rpm • from 2 to 442Nm 	

➤ Digital DC

TPD32 <ul style="list-style-type: none"> • 20 A ... 4800 A (2 and 4 quadrants) • 230 ... 690 Vac, 3ph

Download brochures or see more details at www.gefran.com

GEFRAN

GEFRAN BENELUX

Lammerdries, 14A
B-2250 OLEN
Ph. +32 (0) 14248181
Fax. +32 (0) 14248180
info@gefran.be

**GEFRAN BRASIL
ELETRÔELETRÔNICA**

Avenida Dr. Altino Arantes,
377/379 Vila Clementino
04042-032 SÃO PAULO - SP
Ph. +55 (0) 1155851133
Fax +55 (0) 1155851425
gefran@gefran.com.br

GEFRAN DEUTSCHLAND

Philipp-Reis-Straße 9a
63500 SELIGENSTADT
Ph. +49 (0) 61828090
Fax +49 (0) 6182809222
vertrieb@gefran.de

GEFRAN SUISSE SA

Rue Fritz Courvoisier 40
2302 La Chaux-de-Fonds
Ph. +41 (0) 329684955
Fax +41 (0) 329683574
office@gefran.ch

GEFRAN - FRANCE

4, rue Jean Desparmet - BP 8237
69355 LYON Cedex 08
Ph. +33 (0) 478770300
Fax +33 (0) 478770320
commercial@gefran.fr

GEFRAN INC

Automation and Sensors
8 Lowell Avenue
WINCHESTER - MA 01890
Toll Free 1-888-888-4474
Ph. +1 (781) 7295249
Fax +1 (781) 7291468
info@gefransi.com

GEFRAN INC

Motion Control
14201 D South Lakes Drive
NC 28273 - Charlotte
Ph. +1 704 3290200
Fax +1 704 3290217
salescontact@sieiamerica.com

SIEI AREG - GERMANY

Zachersweg, 17
D 74376 - Gemmingheim
Ph. +49 7143 9730
Fax +49 7143 97397
info@sieiareg.de

GEFRAN SIEI - UK Ltd.

7 Pearson Road, Central Park
TELFORD, TF2 9TX
Ph. +44 (0) 845 2604555
Fax +44 (0) 845 2604556
sales@gefran.co.uk

GEFRAN SIEI - ASIA

Blk. 30 Loyang way
03-19 Loyang Industrial Estate
508769 SINGAPORE
Ph. +65 6 8418300
Fax. +65 6 7428300
info@gefransiei.com.sg

GEFRAN SIEI Electric

Block B, Gr.Fir, No.155, Fu Te Xi Yi Road,
Wai Gao Qiao Trade Zone
200131 Shanghai
Ph. +86 21 5866 7816
Ph. +86 21 5866 1555
gefransh@online.sh.cn

SIEI DRIVES TECHNOLOGY

No.1265, B1, Hong De Road,
Jia Ding District
201821 Shanghai
Ph. +86 21 69169898
Fax +86 21 69169333
info@gefransiei.com.cn

AUTHORIZED DISTRIBUTORS

- | | |
|----------------|----------------------|
| Argentina | Saudi Arabia |
| Austria | Singapore |
| Australia | Slovakia Republic |
| Brasil | Slovenia |
| Bulgaria | South Africa |
| Canada | Spain |
| Chile | Sweden |
| Cyprus | Taiwan |
| Colombia | Thailand |
| Czech Republic | Tunisia |
| Denmark | Turkey |
| Egypt | Ukraine |
| Finland | United Arab Emirates |
| Greece | Venezuela |
| Hong Kong | |
| Hungary | |
| India | |
| Iran | |
| Israel | |
| Japan | |
| Jordan | |
| Korea | |
| Lebanon | |
| Malaysia | |
| Maroc | |
| Mexico | |
| New Zealand | |
| Norway | |
| Peru | |
| Poland | |
| Portugal | |
| Rumania | |
| Russia | |



GEFRAN S.p.A.

Via Sebina 74
25050 Provaglio d'Iseo (BS) ITALY
Ph. +39 030 98881
Fax +39 030 9839063
info@gefran.com
www.gefran.com

Drive & Motion Control Unit

Via Carducci 24
21040 Gerenzano [VA] ITALY
Ph. +39 02 967601
Fax +39 02 9682653
infomotion@gefran.com

Technical Assistance :
technohelp@gefran.com

Customer Service :
motioncustomer@gefran.com
Ph. +39 02 96760500
Fax +39 02 96760278



Certificate No. FM 38167

Rev. 0.1 - 20-6-2008



1S6B02